

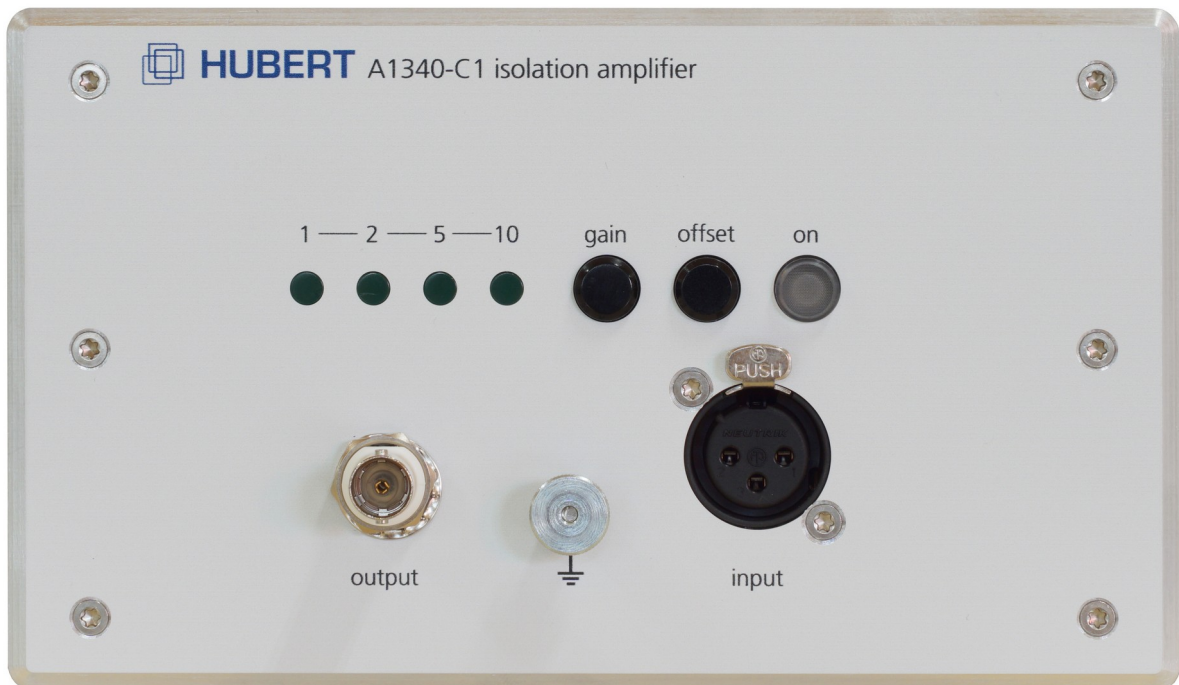

HUBERT

amp up your process

Datasheet



A1340-C1

Isolation Amplifier

DC – 1.7 MHz | 20 V/ μ s | IMRR > 106 dB | 500 V_{AC} / 1 kV_{DC}



1 Product Description

The A1340-C1 is a 3-port isolation amplifier (input, output, USB/network) with optionally selectable input and output potentials. The A1340-C1 is equipped with an input instrument amplifier with high common-mode suppression. The input gain can be optionally selected between 1, 2, 5, and 10 by means of a push button.

The great small-signal band width from DC to > 1.7 MHz ensures excellent signal reproduction. A slew rate of > 20 V/ μ s allows for great large-signal band widths.

Through purely analog signal transmission, the output signal is free from cycle and switching signals. High offset stability is achieved through temperature control of the offset variables. Automatic offset compensation is possible at any time at the push of a button.

Moreover, the A1340-C1 can be remote-controlled via a USB interface (emulated COM port).

2 Features

- 3-port isolation amplifier (input, output, USB/network) with optionally selectable input and output potentials
- Input instrument amplifier with high-power common-mode suppression and switchable gain of 1, 2, 5 or 10
- Great small-signal band width from DC to > 1.7 MHz
- High slew rate of > 20 V/ μ s
- Purely analog signal transmission, i.e. no switching signals in the output signal
- Low output noise of < 1 mV_{pp}
- High input resistance > 1 M Ω for low source load
- High offset stability achieved through temperature control of the offset variables
- Automatic offset compensation possible at any time at the push of a button
- Full remote control via USB interface (emulated COM port) optional



3 Applications

- General lab applications for research, development and testing
- Universally applicable in scenarios with required galvanic isolation
- Galvanic isolation for personal protection, e.g. in medical engineering
- Galvanic isolation for safety reasons, e.g. for signal acquisition via computer systems
- Prevention of ripple pickup
- Measurement of small differential signals in high common-mode voltages
- Suppression of common-mode interference
- Actuation for series connection of amplifiers / power supply units
- Injection of interference signals in supply lines without transformer
- Design of automated test fields

4 Pictures





5 Specifications

Parameters	Specification	Conditions/Moments
		25° C ambient temperature
		Continuous operation
Input	3 pole XLR	1: Input Gnd 2: Signal + 3: Signal -
Gain (switchable)	1, 2, 5, 10 (±1 % ±100 ppm/°C)	
Input Voltage Range	± 10 V	
Common mode input range	< ± 13.5 V	
Maximum Input Level	± 35 V	
Input Impedance	1 MΩ	(2 → 1, 3 → 1)
Input Capacity	typ. 120 pF (2 → 3) typ. 90 pF (2 → 1, 3 → 1)	
Output Voltage Range	± 10 V	
Output Impedance	50 Ω	
Minimum Load	> 1 kΩ	
Output Offset	< ± 1 mV	After Compensation
Output Offset Drift (Temp.)	< ±5 mV/10-50 °C	
Small Signal Frequency Response	DC – 1.7 MHz	
Slew Rate	20 V/μSec	
Noise		
DC - 20 MHz	< 1 mV _{pp}	peak - peak
20 Hz – 2 MHz	< 0.20 mV _{rms}	Gain 1, Gain 2
	< 0.25 mV _{rms}	Gain 5
	< 0.30 mV _{rms}	Gain 10
THD+N	< 0.1%	Sine, 7.07 V _{rms} , 100 Hz/100 kHz
Coupling Capacity	< 33 pF	Input - Output
Coupling Capacity	< 42 pF	Input - Case
Coupling Capacity	< 52 pF	Output - Case



Parameters	Specification	Conditions/Moments
Isolation Mode Rejection Ratio (IMRR)	> 106 dB @ 55 Hz/7,07 V _{rms}	Input 1+2+3 → Output Gnd.
Common Mode Rejection Ration (CMRR)	Gain 1: 90 dB typ. / 80 dB min.	Input 2+3 → 1; 55 Hz/7.07 V _{rms}
	Gain 2: 96 dB typ. / 86 dB min.	
	Gain 5: 101 dB typ. / 91 dB min.	
	Gain 10: 106 dB typ. / 96 dB min.	
Insulation Voltage, permanent	500 V AC, 1 kV DC	Input – Output Input – Case Output – Case
Insulation Test Voltage	1 kV AC, 2 kV DC	60 sec: Input – Output Input – Case Output – Case
Physical Characteristics		
AC Power	230 VAC / 50 Hz	
Remote control	USB	
Operating Temperature	10 °C to 55 °C	
Humidity	< 80 % at 40 °C	non-condensing
Dimensions (W x H x D)	151 x 80.5 x 300 mm	
Weight	Approx. 2,2 kg	



5.1 Square Wave 100 kHz Amplitude 10 V

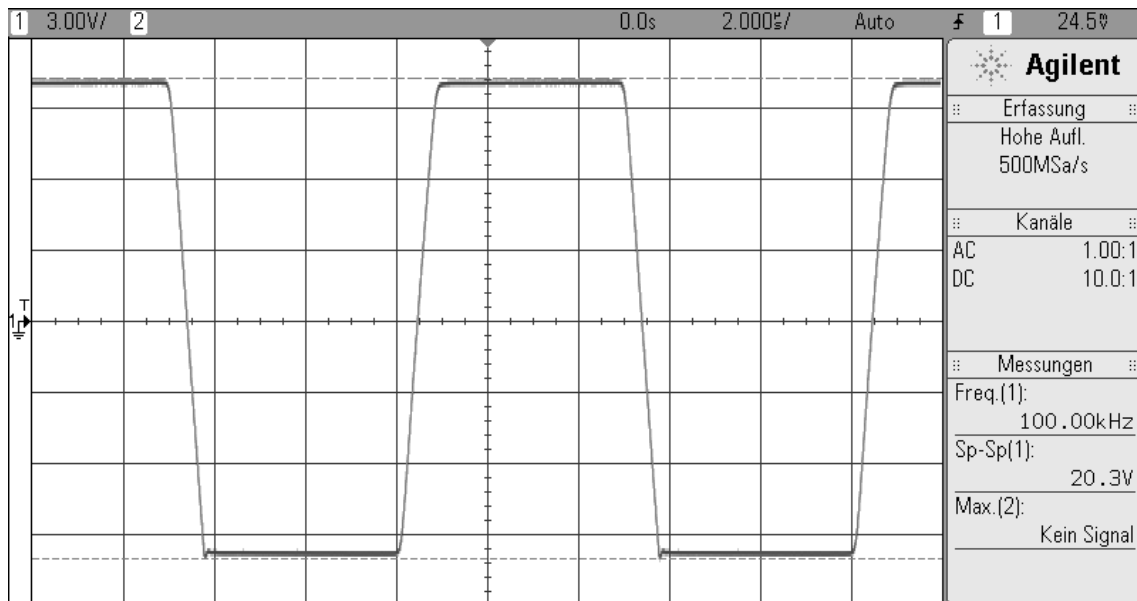

5.2 Square Wave 100 kHz Amplitude 150 mV

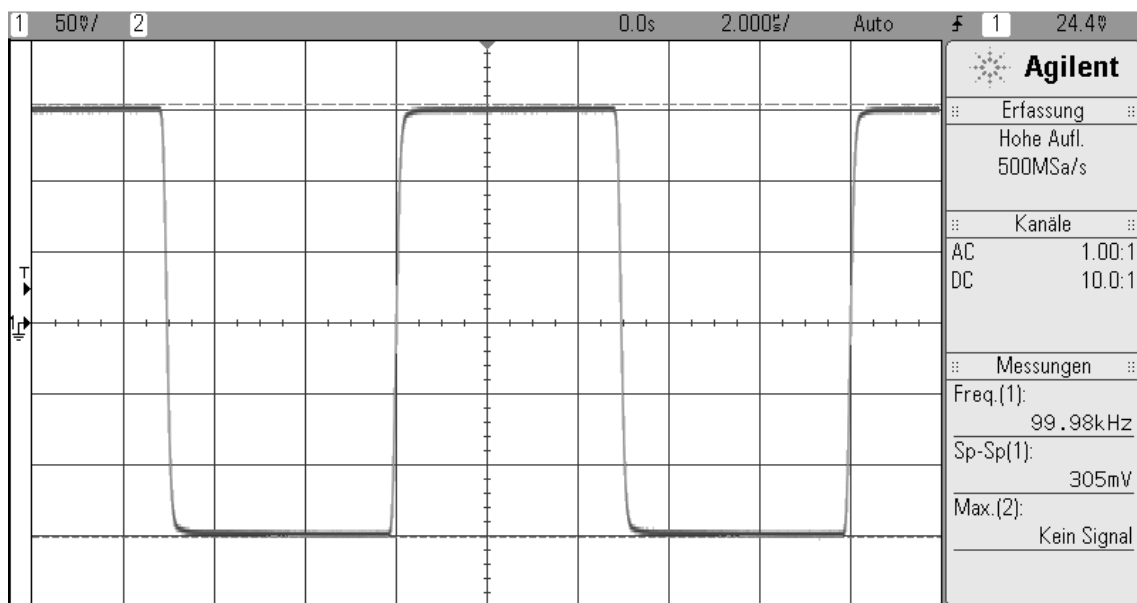



5.3 Small Signal Frequency Response (Gain = 1)

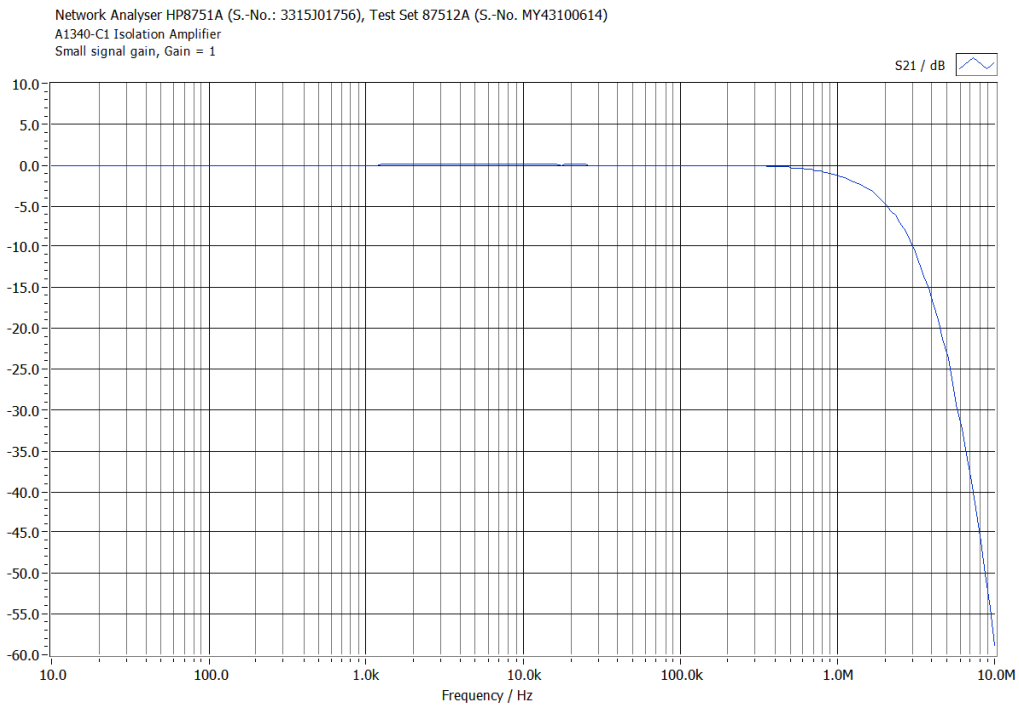

5.4 Small Signal Frequency Response (Gain = 2)

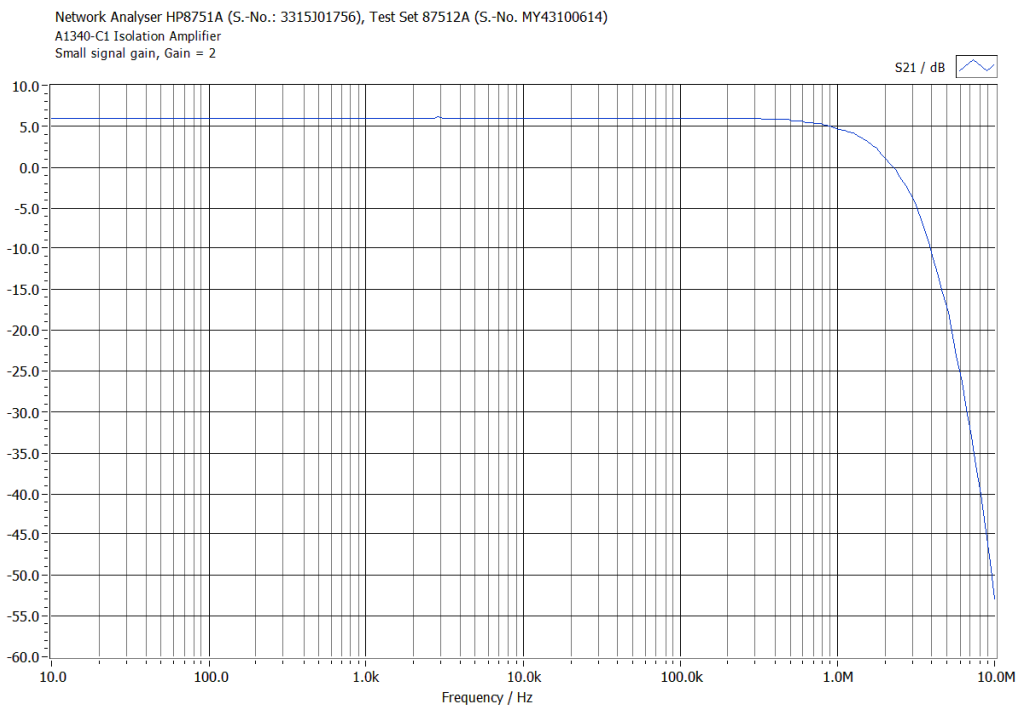



5.5 Small Signal Frequency Response (Gain = 5)

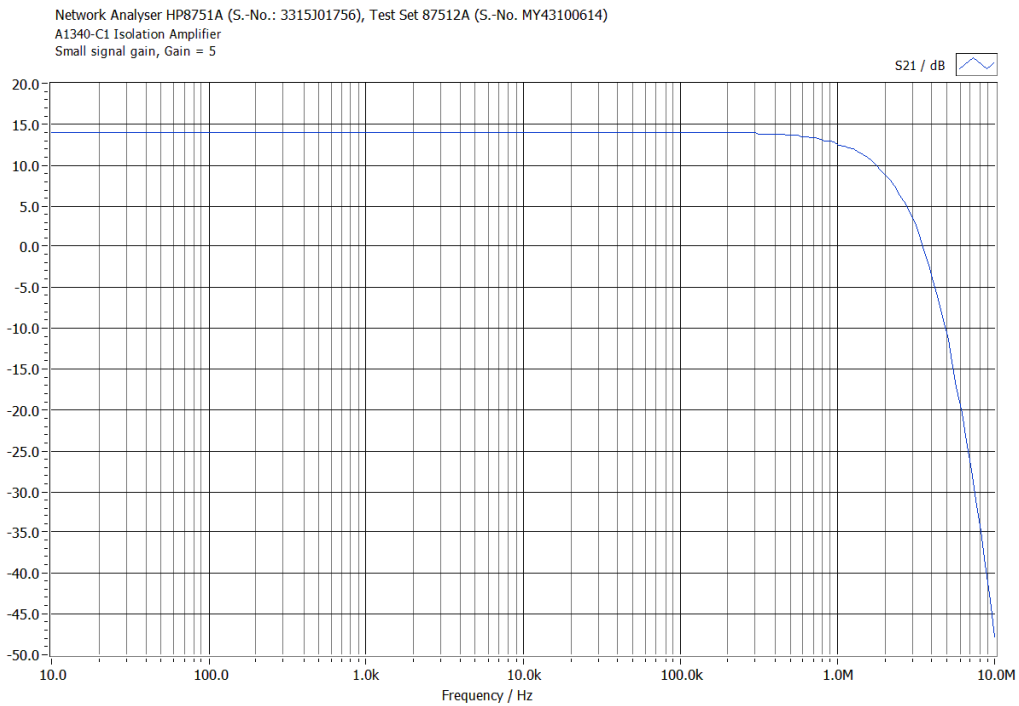

5.6 Small Signal Frequency Response (Gain = 10)

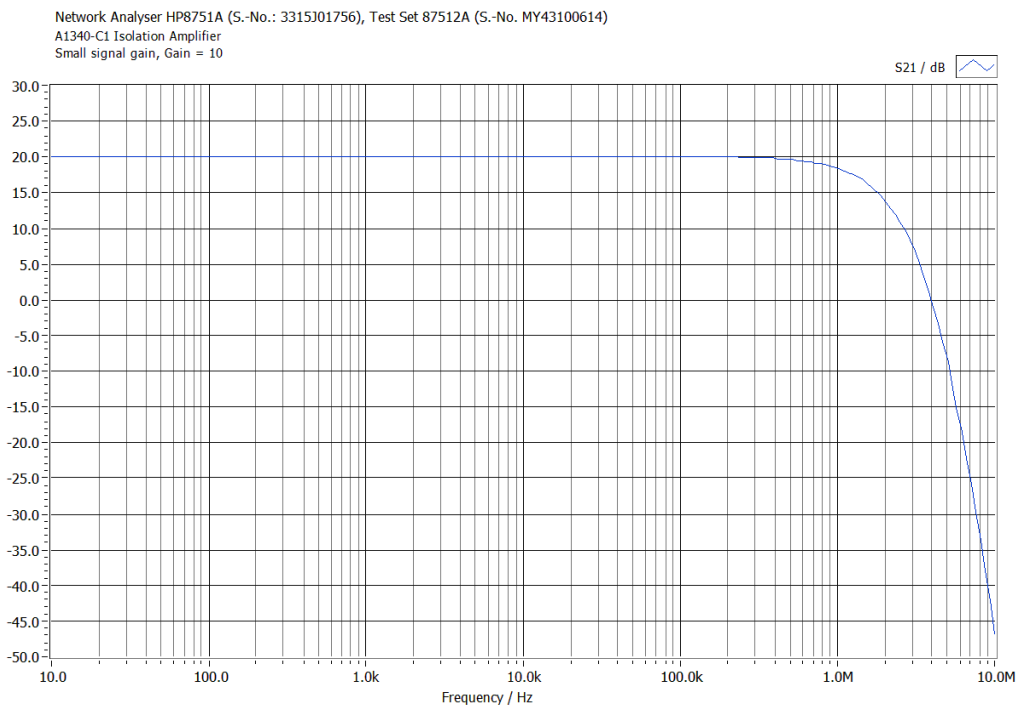



5.7 Common Mode Rejection Ratio (Gain = 1)

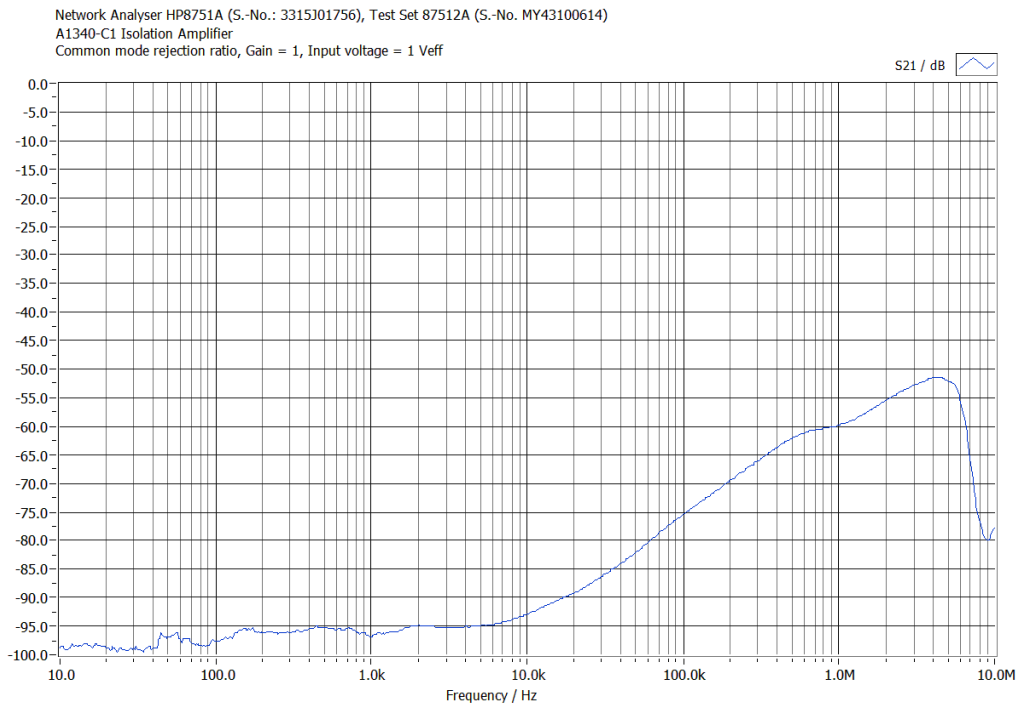

5.8 Common Mode Rejection Ratio (Gain = 2)

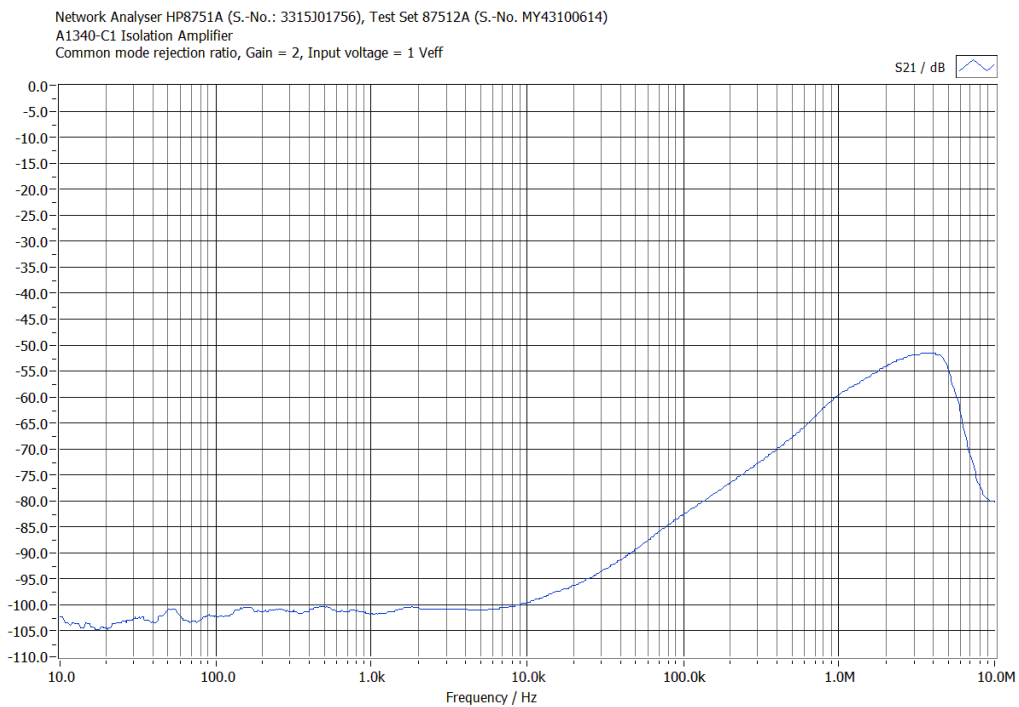



5.9 Common Mode Rejection Ratio (Gain = 5)

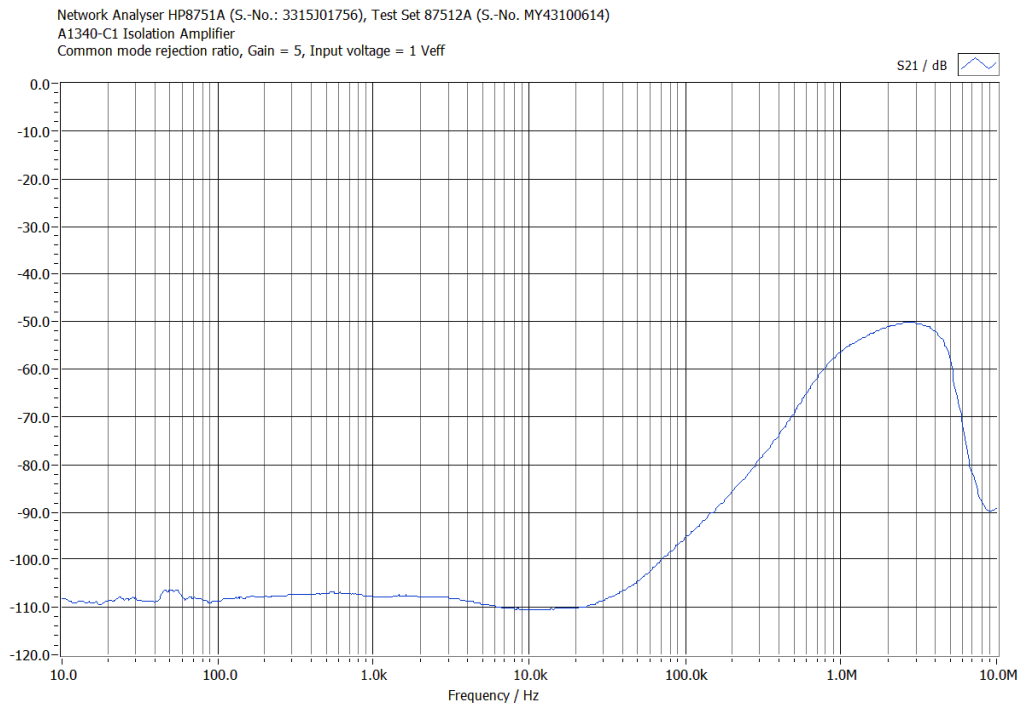

5.10 Common Mode Rejection Ratio (Gain = 10)

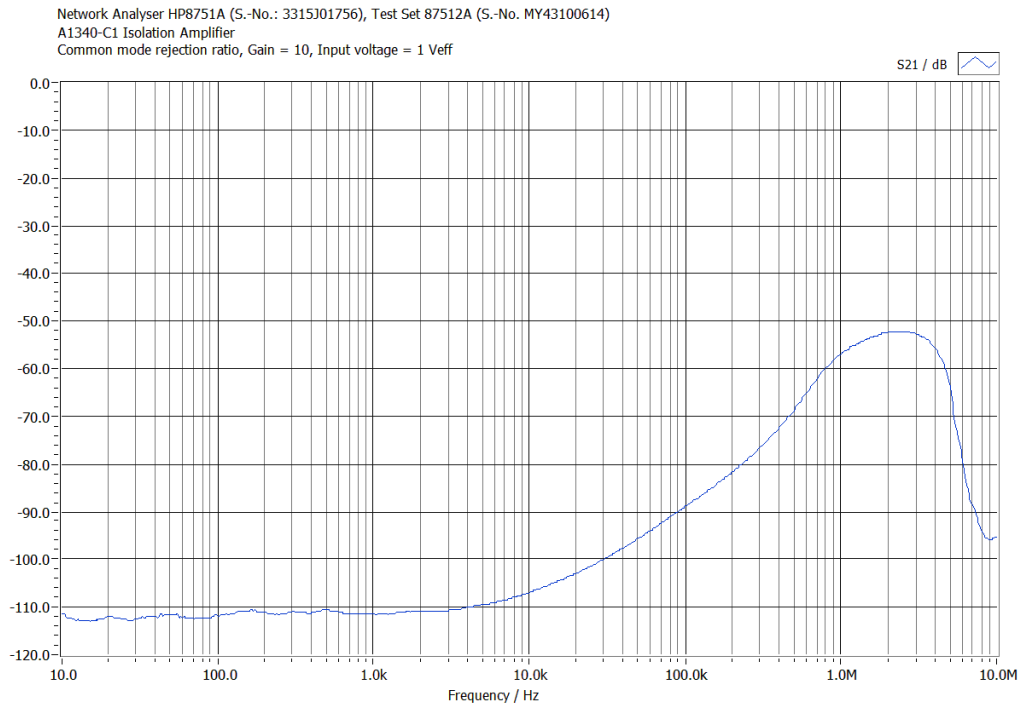



5.11 Isolation Mode Rejection Ratio

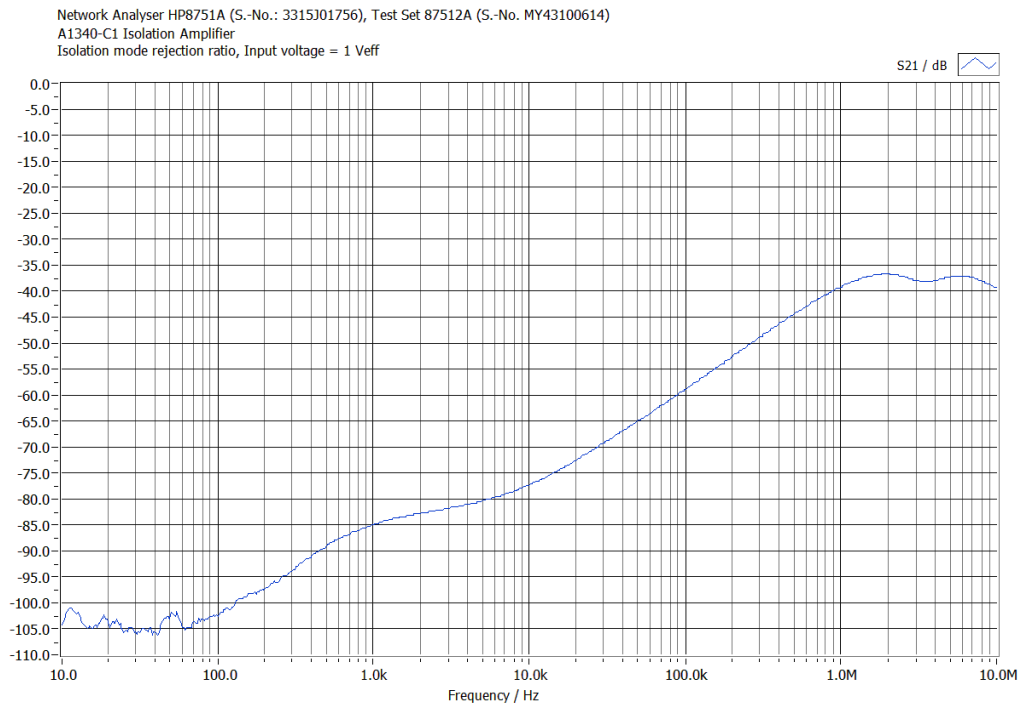



6 Block Diagram

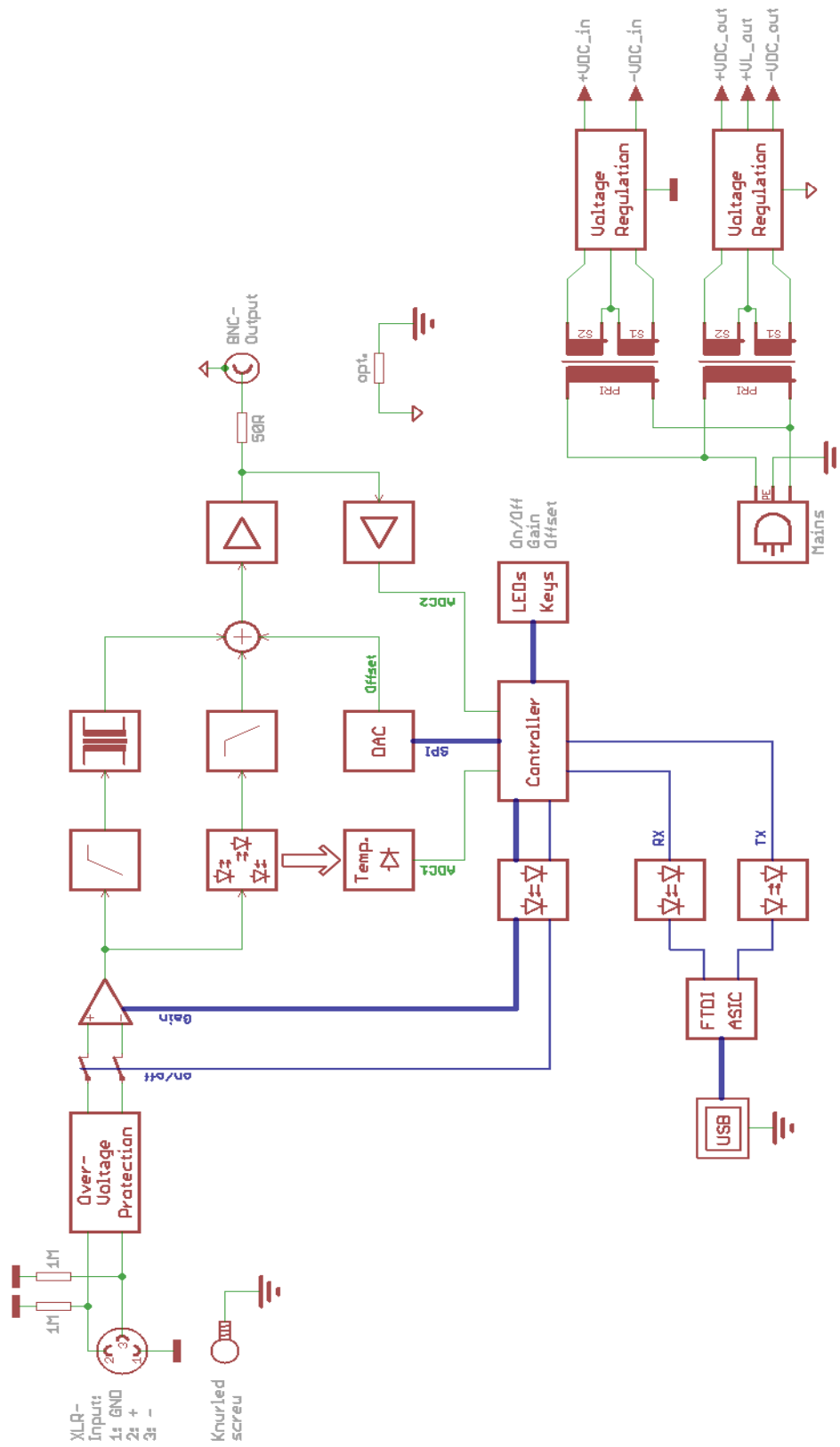



7 Contact

Dr. Hubert GmbH

Dietrich-Benking-Str. 41
44805 Bochum - Germany

Tel. +49 234 970569-0
Fax. +49 234 970569-29
service@drhubert.de

Further information is available on our website www.drhubert.com.

Please find the latest release of this datasheet on our website:
www.drhubert.com



8 Document History

Revision	Date	Changes
2.0	May 2020	New device housing